



































SIMBOLI

	GRO	glavni razdjelni ormar predmetnog prostora (postojeći)
	RO-MR	razdjelnik mrežne sekcije
	RO-AG	razdjelnik agregatske sekcije
	PRO-AG	prikjučni i upravljački ormar (komutacijski) agregata
	UPS	mjesto rezervirano za smještaj besprekidnog napajanja (UPS)
	VTS1	mjesto rezervirano za smještaj komunikacijskog ormara VTS1
		stropna svjetiljka sa grlom i štednom sijalicom E27, vodotijesna, 18W (sprema)
		stropna svjetiljka sa grlom i štednom sijalicom E27, vodotijesna, 18W (sanitarne prostorije)
		stropna ugradbena svjetiljka Downlight sa 2x13W sijalicom (blagavaona)
		stropna viseća svjetiljka, IP55, sa dvije fluo lampe 36W i prigradnjom protupaničnog modula
		stropna ugradbena lampa (Armstrong) sa četiri fluo sijalice 18W
		rasvjetno tijelo sa prikjučnicom
	G1	sklopna garnitura G1: 5x obična sklopka
	G2	sklopna garnitura G2: 3x izmjenična sklopka; sklopna garnitura G3: 3x obična sklopka;
	G3	
		sklopke: obična, serijska, izmjenična
		električni izvodi za električnu grijalicu vode; za ventilator
		električni izvodi za napu; klimu
		
		prikjučnice: jednostruka p/ž (2-dvostruka); sa poklopcem p/ž (2-dvostruka); s poklopcem n/ž
		priklj. garniture: 2x shuko i 2x RJ45
	PG1	priklj. podžbukna garnitura PG1: 2x shuko UPS; 2x shuko AGREGAT; 2x shuko MREŽA i 4x RJ45
	PG2	priklj. podžbukna garnitura PG2: 2x shuko AGREGAT; 2x shuko MREŽA i 4x RJ45
	PG3	priklj. podžbukna garnitura PG3: 2x shuko UPS; 2x shuko AGREGAT; 2x shuko MREŽA i 2x RJ45
	PG4	priklj. podžbukna garnitura PG4: 4x shuko UPS; 4x shuko AGREGAT; 2x shuko MREŽA i 8x RJ45
	KG1	priklj. kanalna garnitura KG1: 2x shuko UPS; 2x shuko AGREGAT; 2x shuko MREŽA i 2x RJ45
	KG2	priklj. kanalna garnitura KG2: 4x shuko UPS; 4x shuko AGREGAT; 4x shuko MREŽA
	KG3	priklj. kanalna garnitura KG3: 2x shuko UPS; 2x shuko AGREGAT; 2x shuko MREŽA
		dvostruka podna ugradbena prikjučna kutija sa kompletom priključnih garnitura: 1. kutija: 4x shuko UPS; 1x shuko AGREGAT i 4x RJ45 2. kutija: 4x shuko UPS; 1x shuko AGREGAT i 4x RJ45
		kutija za izjednačenje potencijala
		protupanične lampe: sa piktogramom izlaza; sa piktogramom smjera; bez piktograma
		
		

 <p>Elektro projekti i sustavi d.o.o. Split</p>	Investitor	PLOVPUT d.o.o. Split Sektor sigurnosti plovidbe	MP				
	Građevina	UREĐENJE PROSTORA PRIZEMLJA ZGRADE ORP - SPLIT RADIO ZA POTREBE VTMIS SLUŽBE MMPI					
	Naziv	Projekt elektroinstalacija	Naslov				
	Faza	Izvedbeni projekt	Simboli				
Broj projekta	E-441	Gl. projektant	Veljko Peović d.i.g.				
Z.O.P.	01/2010	Projektant	A. Kraljević, dipl.ing.el.	Izmjena	Mjerilo	Nacr. br.	List
Mapa	2	Suradnik	A. Petrović			441-201	1
Datum	03.2010.						Listova 2

Priključne podžbukne garniture PG:
Podžbukna ugradnja (tip kao Vimar Plana)

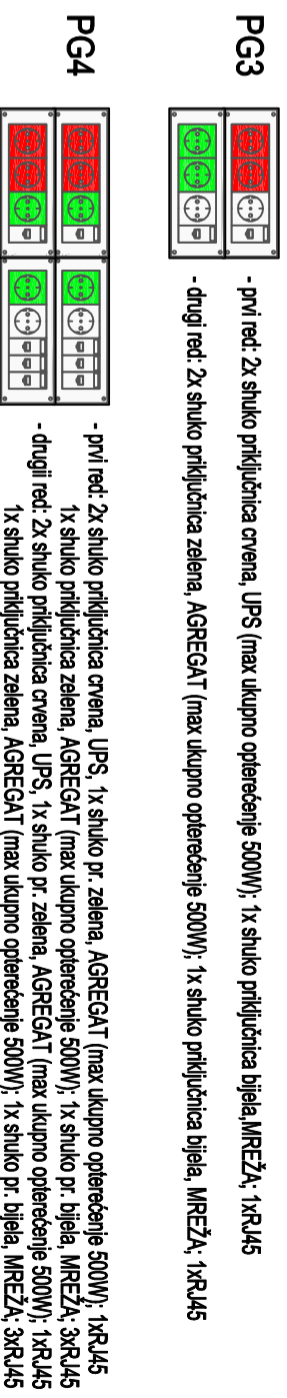
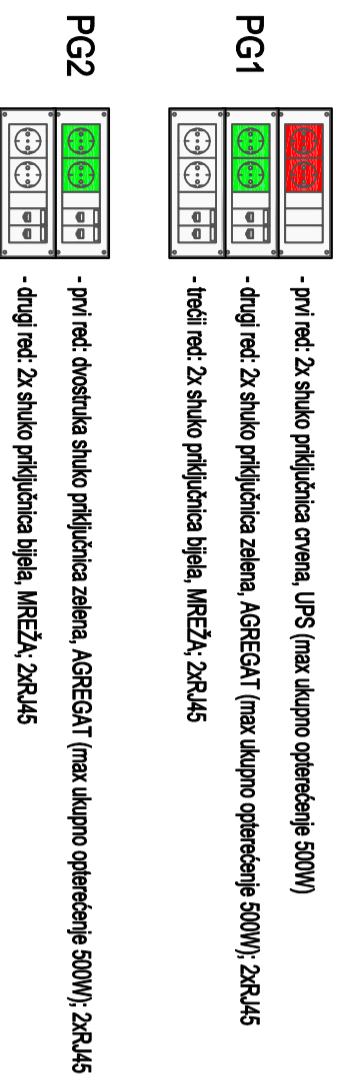

Priključne kanalne garniture KG:
Ugradnja u PVC parapetne kanale (tip kao Legrand Mosaic)

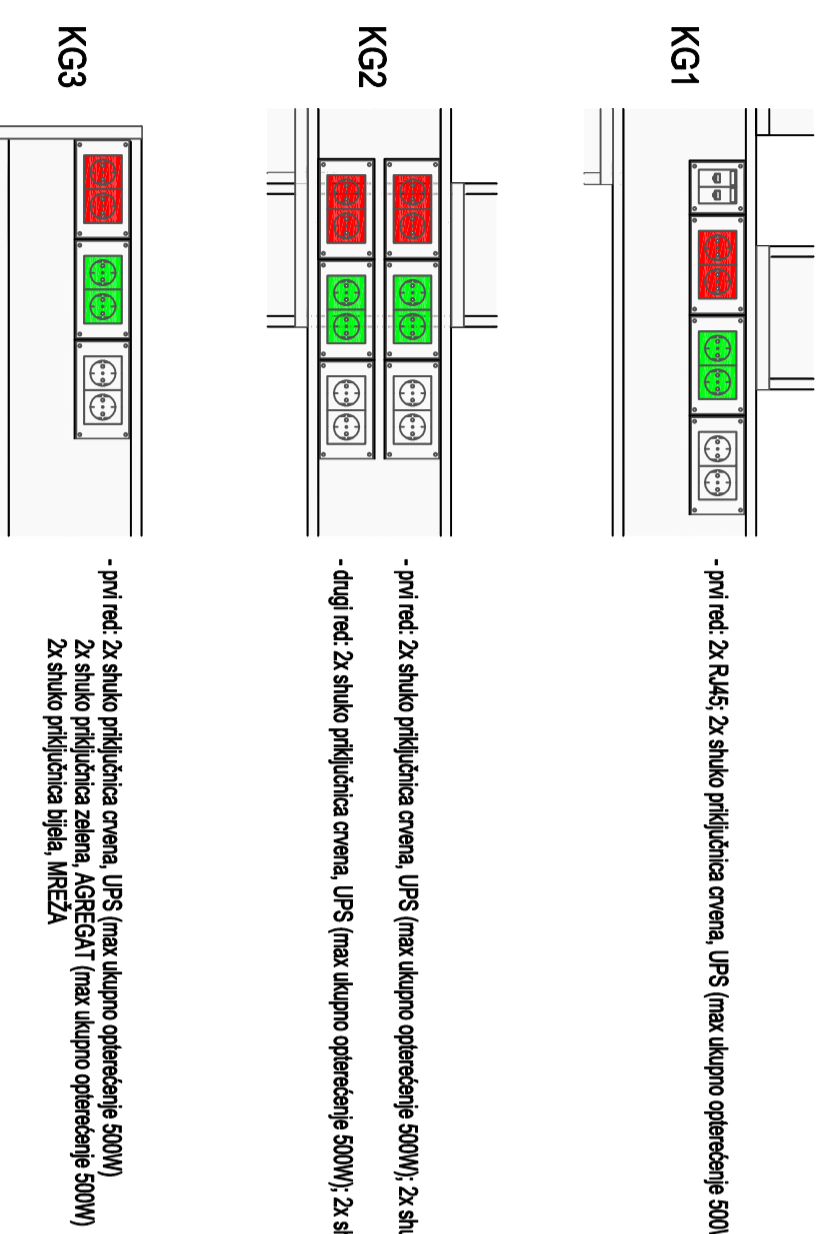

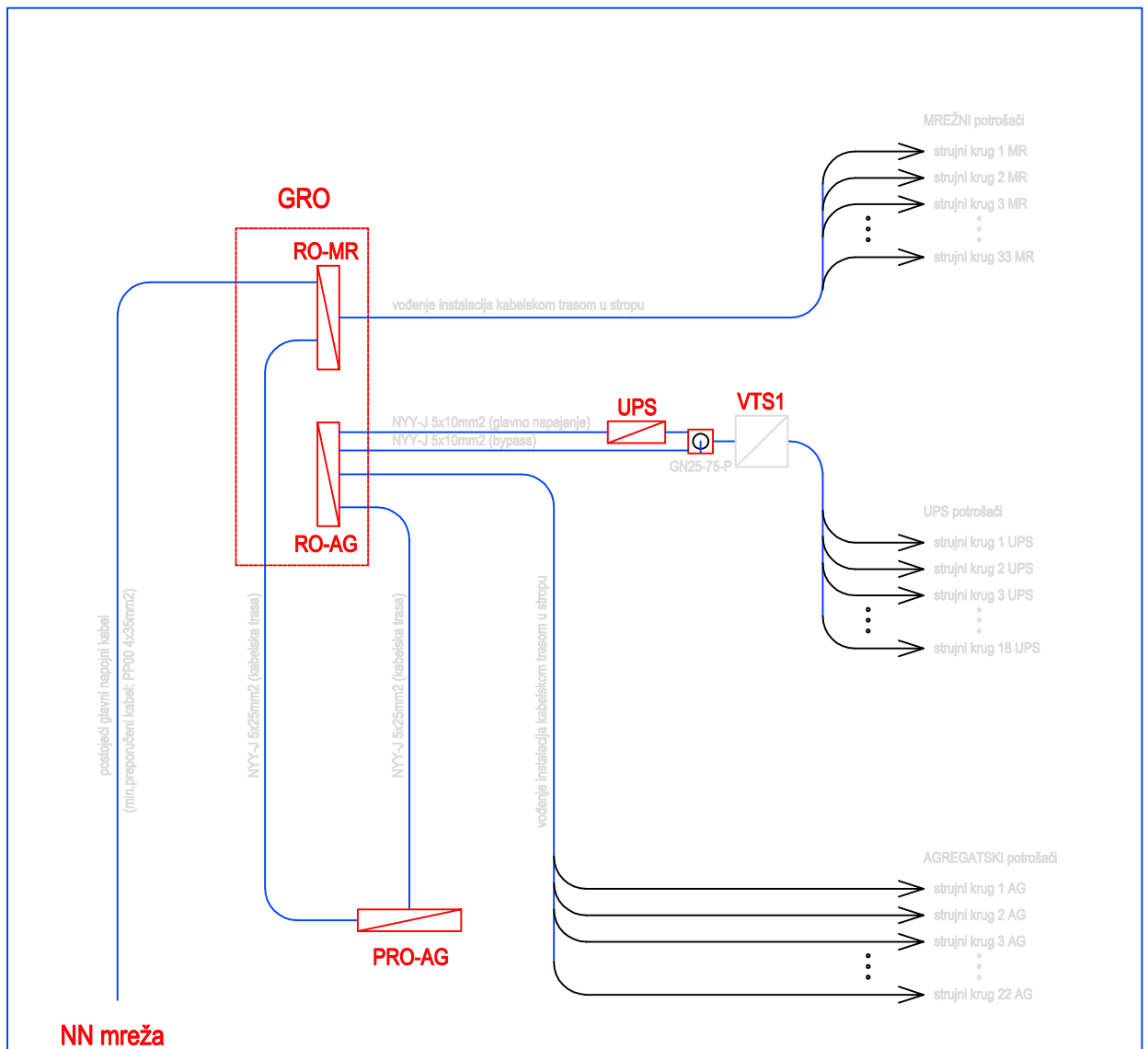

 <p>Elektro projekti i sustavi d.o.o. Split</p>		Investitor	PLOVPUT d.o.o. Split Sektor sigurnosti plovidbe	MP			
		Gradevinia	UREĐENJE PROSTORA PRIZEMLJA ZGRADJE ORP - SPLIT RANO ZA POTREBE VTMIS SLUŽBE MARI	Naslov			
Broj projekta	E-441	Naziv	Projekt elektroinstalacija	Simboli Priključne garniture			
Z.O.P.	01/2010	Faza	Izvedbeni projekt				
Mapa	2	Gl. projektant	Veljko Peović d.i.g.				
Datum	03.2010.	Projektant	A. Kraljević, dipl.ing.el.				
		Suradnik	A. Petrović	Izmjena	Mjerilo	Nacrt br.	List
						441-201	Listova 2

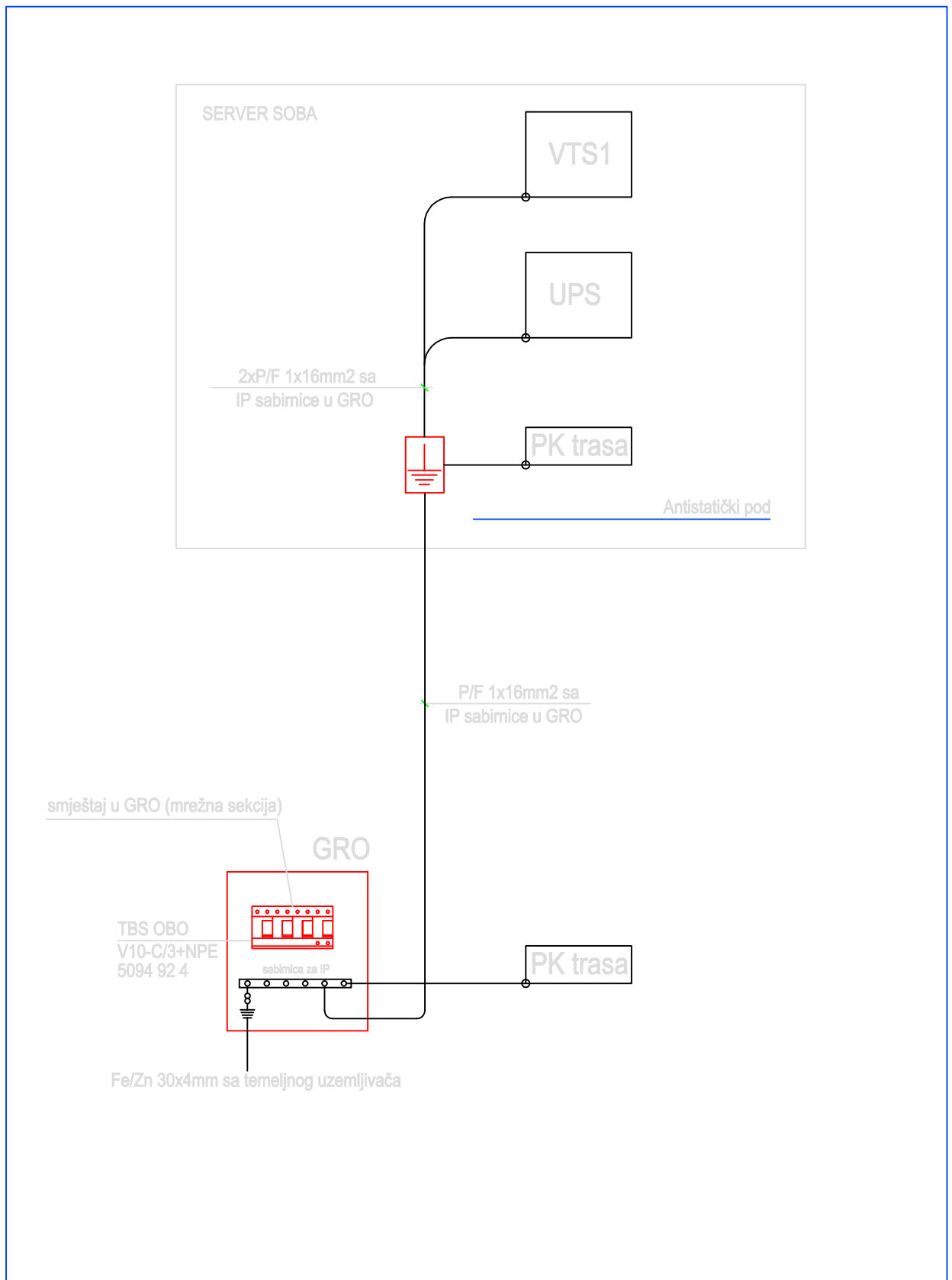

- GRO** - glavni razdjelni ormar objekta (postojeći)
- RO-MR** - razdjelnik mrežne sekcije ormara GRO
- RO-AG** - razdjelnik agregatske sekcije ormara GRO
- PRO-AG** - priključno-upravljački ormarić agregata
- UPS** - samostojeći uređaj za besprekidno napajanje
- VTS1** - komunikacijski ormar - smještaj sklopne opreme UPS razvoda

 <p>Elektro projekti i sustavi d.o.o. Split</p>	Investitor	PLOVPUT d.o.o. Split Sektor sigurnosti plovidbe	MP					
	Građevina	UREĐENJE PROSTORA PRIZEMLJA ZGRADE ORP - SPLIT RADIO ZA POTREBE VTMIS SLUŽBE MMPI						
	Naziv	Projekt elektroinstalacija		Naslov				
Broj projekta	E-441	Faza	Izvedbeni projekt	Blok sheme Elektroenergetski razvod				
Z.O.P.	01/2010	Gl. projektant	Veljko Peović d.i.g.					
Mapa	2	Projektant	A. Kraljević, dipl.ing.el.	Izmjena	Mjerilo	Nacr. br.	List	1
Datum	03.2010.	Suradnik	A. Petrović			441-202	Listova	3



 <p>Elektro projekti i sustavi d.o.o. Split</p>	Investitor	PLOVPUT d.o.o. Split Sektor sigurnosti plovidbe	MP					
	Građevina	UREĐENJE PROSTORA PRIZEMLJA ZGRADE ORP - SPLIT RADIO ZA POTREBE VTMIS SLUŽBE MMPI						
	Naziv	Projekt elektroinstalacija		Naslov				
Broj projekta	E-441	Faza	Izvedbeni projekt	Blok sheme - zaštita od prenapona				
Z.O.P.	01/2010	Gl. projektant	Veljko Peović d.i.g.					
Mapa	2	Projektant	A. Kraljević, dipl.ing.el.	Izmjena	Mjerilo	Nacr. br.	List	2
Datum	03.2010.	Suradnik	A. Petrović			441-202	Listova	3

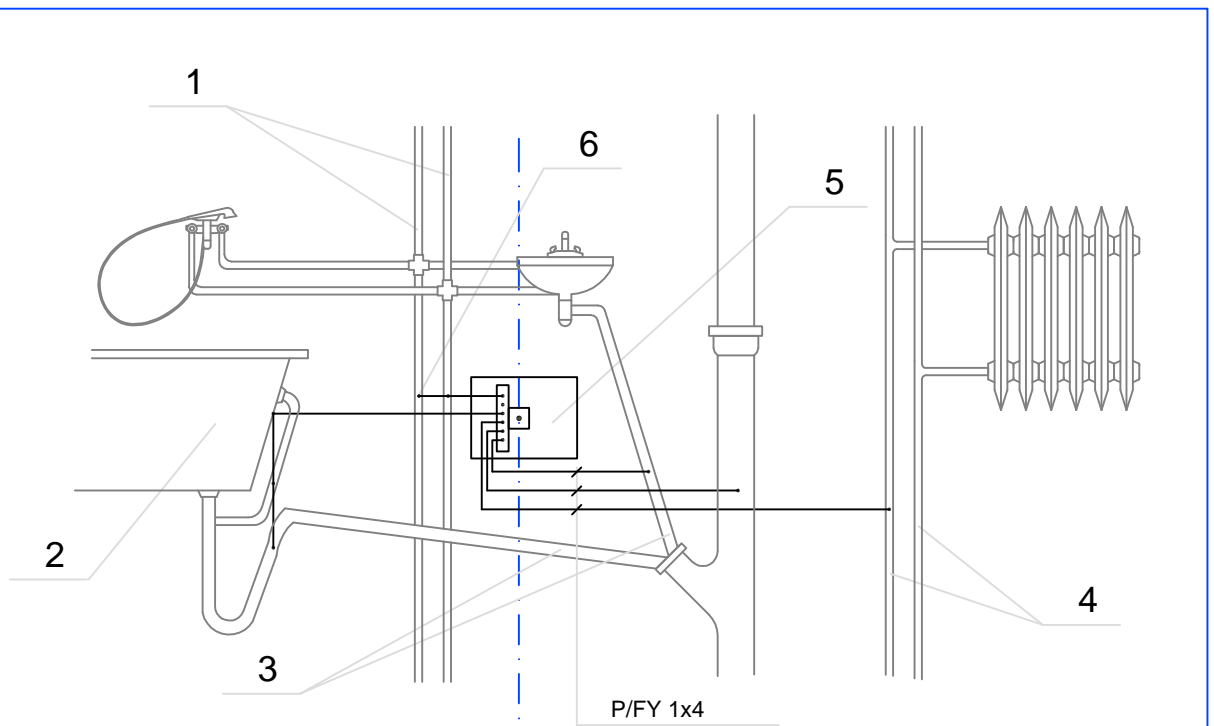

P/FY 1x10
prema PE sabirnici u GRO

1. vodovodne cijevi
2. metalna kada
3. metalne cijevi kanalizacije
4. metalne cijevi centralnog grijanja
5. kutija za izjednačenje potencijala
6. metalna objumica za cijev

žuto/zeleni vodič u kabelu NYY-J 5x10mm²
prema PE sabirnici u GRO

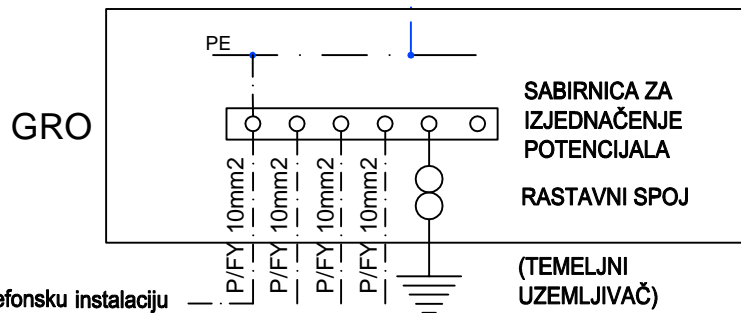

 <p>Elektro projekti i sustavi d.o.o. Split</p>	Investitor	PLOVPUT d.o.o. Split Sektor sigurnosti plovidbe	MP				
	Građevina	UREĐENJE PROSTORA PRIZEMLJA ZGRADE ORP - SPLIT RADIO ZA POTREBE VT MIS SLUŽBE MMPI		Naslov			
	Broj projekta	E-441	Naziv	Blok sheme - instalacija izjednačenja potencijala			
Z.O.P.	01/2010	Faza	Izvedbeni projekt				
Mapa	2	Gl. projektant	Veljko Peović d.i.g.	Izmjena	Mjerilo	Nacr. br.	List 3
Datum	03.2010.	Projektant	A. Kraljević, dipl.ing.el.			441-202	Listova 3
		Suradnik	A. Petrović				